

RACE TRANSPORTER

STYLE, SUBSTANCE, SPACE

BRIAN JAMES TRAILERS

» Connected to you



UNITED KINGDOM

CONTENTS

04 RACE TRANSPORTER 4

Evolved, Versatile, Value

10 RACE TRANSPORTER 5

Function, Features, Style

16 RACE TRANSPORTER 6

Purpose, Precision, Performance

22 RACE TRANSPORTER 4, 5 & 6

Options overview

26 RACE TRANSPORTER 4, 5 & 6

Standard equipment

28 RACE TRANSPORTER 4, 5 & 6

Optional equipment

30 BRIAN JAMES TRAILERS

Contact details

RACE TRANSPORTER
STYLE, SUBSTANCE, SPACE





RACE TRANSPORTER 4



RACE TRANSPORTER 4 EVOLVED, VERSATILE, VALUE

DELIVERING
PREMIUM
VALUE

The evolved **Race Transporter 4** now presents the highest quality standards with advanced features previously unavailable at this level. Unmatched value and specification makes **Race Transporter 4** ideal for high level motorsport.

All models feature a full width, full height rear door ramp with gas spring assistance. Low ground clearance competition cars load easily thanks to a combination of ramp doors combined with hydraulic tilt-bed.

Race Transporter 4 standard specification provides the same high quality chassis and body as other Race Transporters, and allows for a bespoke specification to suit individual circumstances.



RACE TRANSPORTER 4

RACE TRANSPORTER 4

Evolved, Versatile, Value

Sharing many of the Race Transporter 5 and 6 features, the **Race Transporter 4** achieves a generational leap in aesthetics and specification. It now includes a full width and height rear door for easy access, finished with an exterior body moulding. Punched decking, hydraulic tilt-bed, electric winch and locking coupling are all standard.

Designed for the safe transportation of both road vehicles and race cars, **Race Transporter 4** is available with a comprehensive range of options to perfectly compliment your individual needs. (see p22)

Race Transporter 4 provides the most affordable fully enclosed transportation solution without compromising on quality, features or space.



- Large 'Gullwing' side doors provide practical access to vehicles from both sides of the trailer.



○ Body Colour

Race Transporter 4 range is available in white or black bodywork.



- Front access hatches are convenient for reaching inside during vehicle strapping.

- **Hydraulic tilt-bed**
Powerful hydraulic hand pump and cylinder powers the tilt-bed operation to create a convenient low loading angle.



- **High quality lighting system** - automotive specification lamps stylishly mounted. Front and side marker lamps are LED technology as standard.

- **Upgrade to full LED lighting**
Replace bulbed rear lamps with LED technology.

LED lamps: Note

LED lamps are not compatible with all towing vehicles. This may cause unintended consequences. Please check compatibility. A mix of filament and LED lamps is possible.

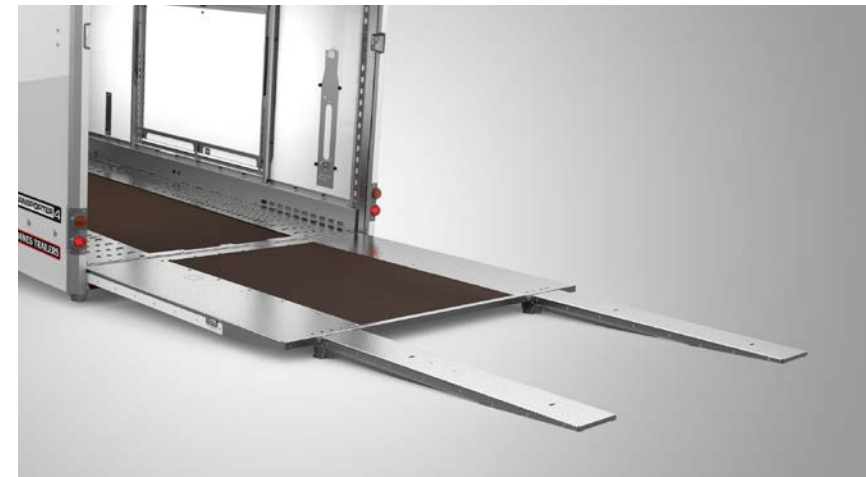

- **Assistor ramps** offer ultra-low loading angles. Stored just inside the trailer rear door for travel.

- **Daylight roof** takes advantage of natural daylight to create an enhanced working environment.



● **Twin axle and lightweight low chassis** ensures excellent towing stability.

○ **Wheel options**
Alloy wheels available in Silver or diamond cut Anthracite.



 **MULTIPLE ANCHOR POINTS**

● **Multiple anchor points** and high strength decking provides strap attachment locations and a high level of grip.

○ Optional **deck slick pads** are available to protect race tyres.



● **Electric winch**, 12V with remote control lead. 4,500 lbs capacity, roller fairlead, wire cable and snap hook, plus on-board battery power. Separate mains battery charger also included.

○ Fully adjustable, quick release wheel chock. Suitable for cars with low splitters.

○ Commercial type wheel chocks also available. (see p24)

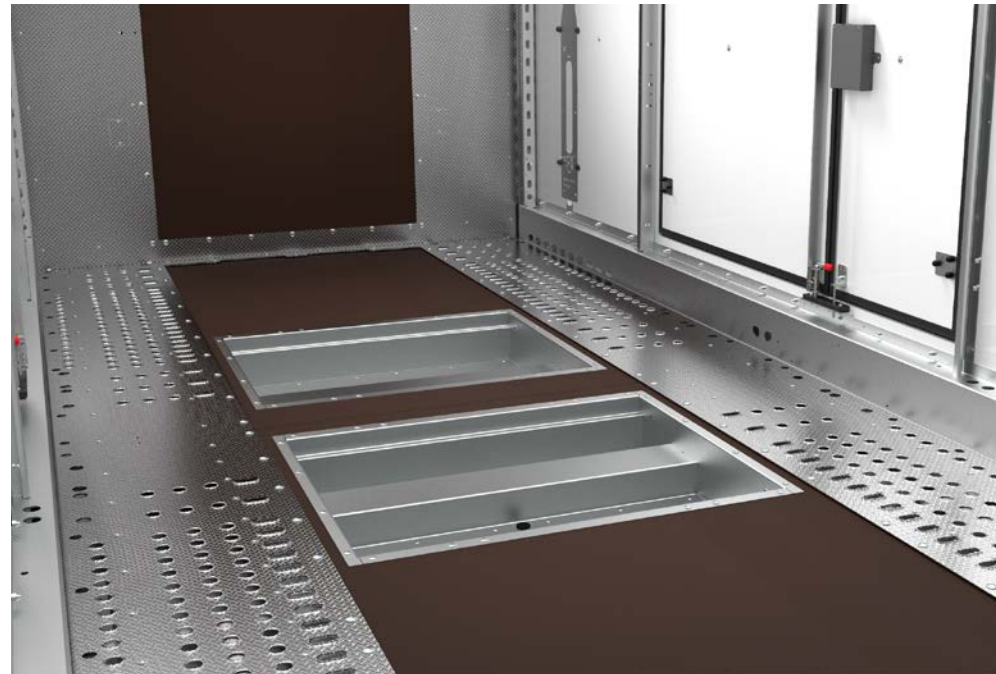
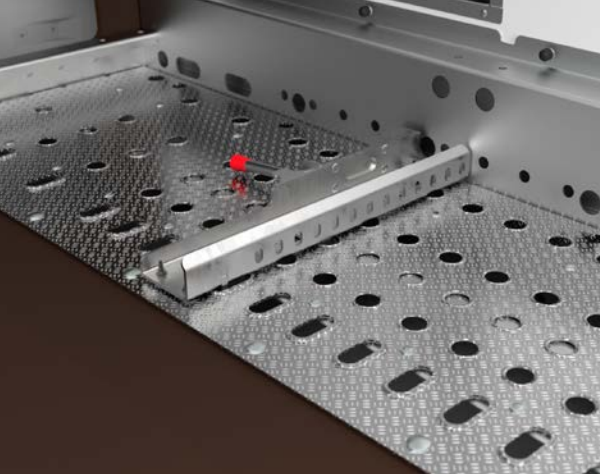

○ Floor storage trays provide an ideal location for heavy/bulky items. Factory fit option.

○ Aluminium gas strut assisted lids available.



○ x3 LED lighting strips provide an excellent ambient light effect.

○ LED flood light package fully illuminates the trailer interior. Switched separately. Powered by on-board battery and includes integrated bodywork housings.



○ Tie-down wheel 'sleeve' straps Approved by car manufacturers and race teams alike, these straps hold the vehicle safely and securely without straining the suspension geometry.

RACE TRANSPORTER 5



RACE TRANSPORTER 5 FUNCTION, FEATURES, STYLE



CLASS
LEADING
QUALITY



Race Transporter 5 provides users requiring optimum access and high specification with the ideal solution.

Race Transporter 5 is available in a choice of lengths, widths and capacities. The low bed chassis provides stable and safe towing which combined with tilt-bed operation ensures low vehicles are easily accommodated.

All **Race Transporter 5** models feature a full width ramp door with single closing and locking mechanism and full bodywork to finish the look. Standard equipment also includes a pair of asymmetric side doors with personnel access, a pair of forward hatch doors, a remote control electric winch, wheel strap set and wheel chocks. Other convenient features include external and internal LED lighting throughout plus under deck storage.



RACE TRANSPORTER 5

RACE TRANSPORTER 5

Function, Features, Style

From its dependable ride to an abundance of usability features and high level of standard equipment, **Race Transporter 5** is a performer through and through.

Recent updates include revised styling inside and out, a full length black vinyl graphic, triple-grip punched aluminium decking, deck storage solutions and lids. Modern alloy wheel options in silver or diamond-cut black anthracite finish completes the high quality presentation.

Our commitment to functionality is found in everything we do. **Race Transporter 5**, in common with the Race Transporter range is made from high-grade materials to ensure strength and long term durability.



● Body Colour

Race Transporter 5 range is available in white or black bodywork.



● **Large twin side doors** and front hatches provide practical access to trailers. Separately opening pedestrian doors work well in tight spaces.



● **Front access hatches** are convenient for reaching inside during vehicle strapping.



● **Daylight roof** takes advantage of natural daylight to create an enhanced working environment.

● Full width, full height **rear door ramp** features a high quality moulded rear bodywork. A central "easy close" integrated locking mechanism is key to operator convenience.



● **Hydraulic tilt-bed**
Powerful hydraulic hand pump and cylinder powers the tilt-bed operation to create a convenient low loading angle.

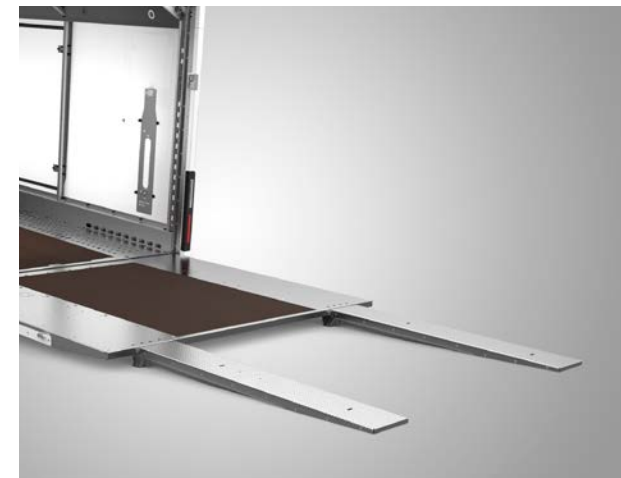

○ **Assistor ramps** offer ultra-low loading angles. Stored just inside the trailer rear door for travel.



● **Full LED lighting**

LED lights are both super bright and reliable. All lamps are LED technology as standard.

LED lamps: Note

LED lamps are not compatible with all towing vehicles. This may cause unintended consequences. Please check compatibility.

● **x3 LED lighting strips as standard**



○ **LED flood light package** fully illuminates the trailer interior. Switched separately. Powered by on-board battery and includes integrated bodywork housings.

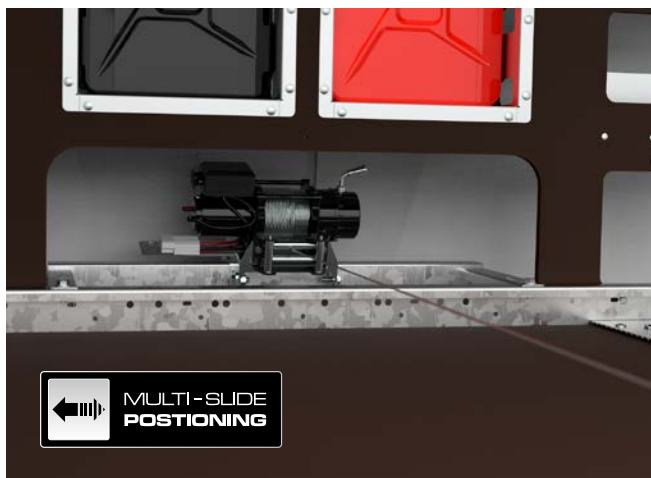
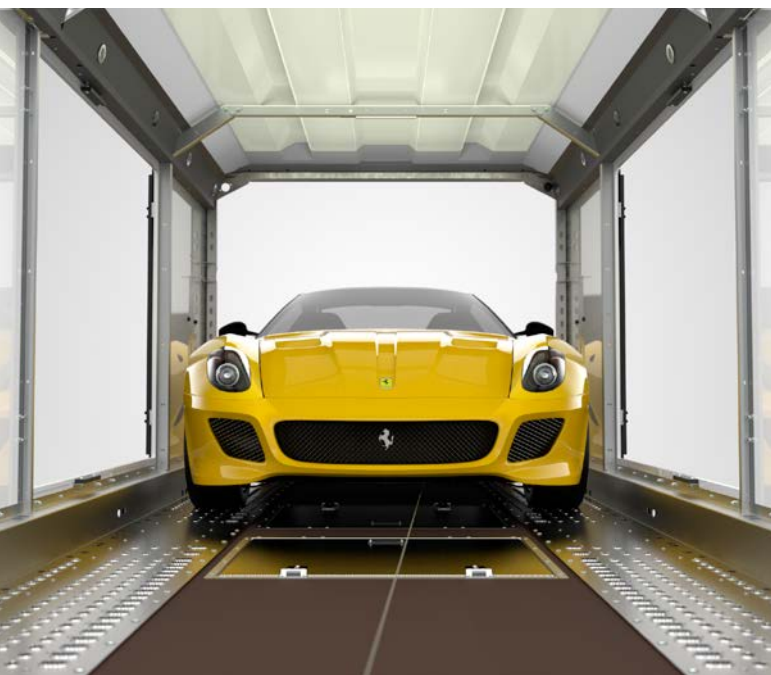

● **Electric winch, 12V with remote control lead.** 4,500 lbs capacity, roller fairlead, wire cable and snap hook. On-board battery power. Multi-slide positioned mounting allows suits all towing eye locations.

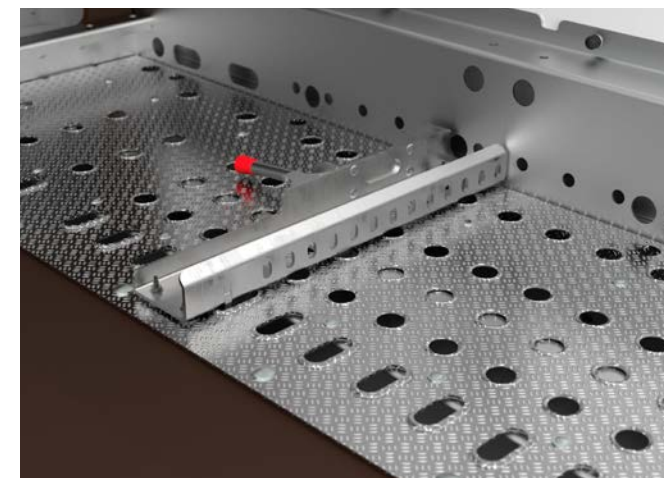

● **Fully adjustable, quick release wheel chocks** Suitable for cars with low splitters.

○ **Commercial type wheel chocks** also available. (see p24)

● **Multiple anchor points** and high strength decking provides strap attachment locations and a high level of grip.

○ Optional **deck slick pads** are available to protect race tyres.

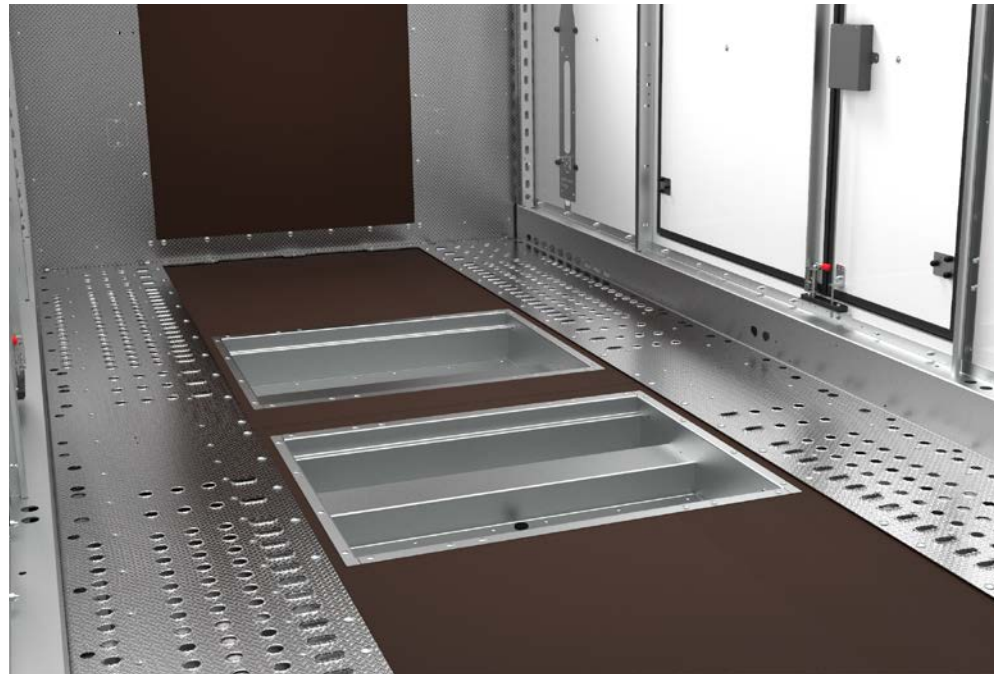
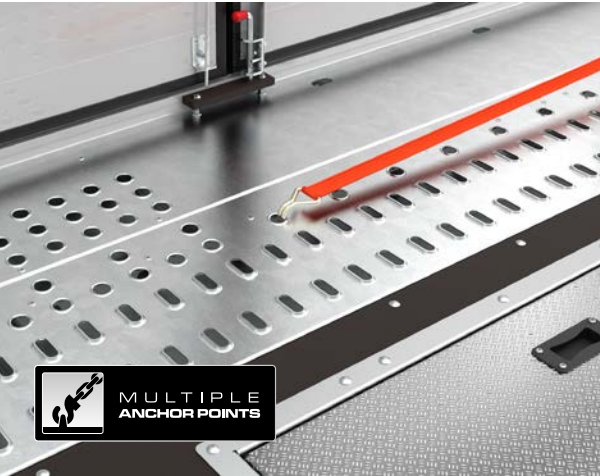

● **Floor storage trays** provide an ideal location for heavy/bulky items.

○ **Aluminium gas strut assisted lids** available.



● **Tie-down wheel 'sleeve' straps**
Approved by car manufacturers and race teams alike, these straps hold the vehicle safely and securely without straining the suspension geometry.



● **Twin axle** and light weight **low chassis** ensures excellent towing stability.

○ **Wheel options**
Alloy wheels available in Silver or diamond cut Anthracite.

● Standard ○ Optional at extra cost

RACE TRANSPORTER 6



RACE TRANSPORTER 6

PURPOSE, PRECISION,
PERFORMANCE

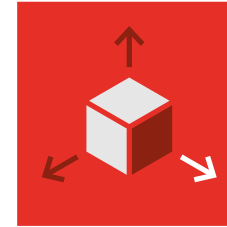

**BUILT
ON
INNOVATION**



Whether for supercar exotics, motorsport or classics, **Race Transporter 6** achieves unrivalled practicality and competence.

Offering two width and three length options, the widest being the same as an HGV transporter, **Race Transporter 6** will handle wide sports cars with ease. The additional space provides an invaluable working environment for daily transport operations or small teams at race meetings.

Along with a high standard specification, the range and scope of individual options for storage and operational features further extends its capability.

Race Transporter 6 chassis design positions wheels under the bed providing a full width floor. To manage bed height and maintain a low centre of gravity **Race Transporter 6** has tri-axle running gear with 10" wheels and low profile tyres. 6.5m bed length models feature a 13" low profile tyre for extra durability.



RACE TRANSPORTER 6

RACE TRANSPORTER 6

Purpose, Precision, Performance

Built to outperform, **Race Transporter 6** has been designed around both transport operations and race weekends.

Light-weight materials and intelligent designs provide strength throughout. Combined with a proven chassis and advanced suspension, your journey with **Race Transporter 6** will exceed expectations.

Race Transporter 6 includes many specific features orientated towards providing a productive working environment. Multiple tyre and equipment storage locations are available, with enhanced options offering tailored solutions. Standard interior lighting, remote controlled electric winch, asymmetric side doors and hatches all contribute to making loading effortless.

- **Electric tilt operation** effortlessly creates a low loading angle. Onboard powered.

- **Optional tilt-bed control via App.**



- **Large twin side doors** and front and rear hatches provide practical access to trailers. Separately opening pedestrian doors work well in tight spaces.



- **Rear chassis rollers**



- **Front and rear access hatches** are convenient for reaching inside during vehicle strapping.

- **Electric winch**, 12V with remote control lead. 4,500 lbs capacity, roller fairlead, wire cable and snap hook. On-board battery power. Multi-slide mounting allows side-to-side positioning to suit all towing eye locations.

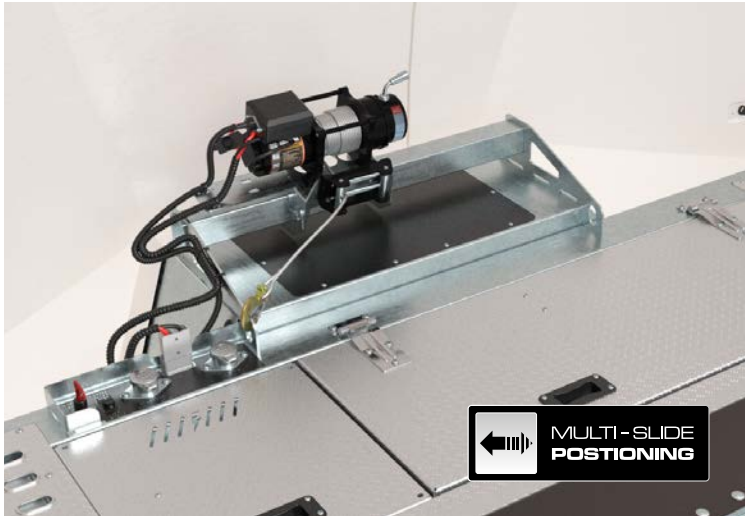

← ||| **MULTI-SLIDE POSITIONING**

- **Daylight roof** takes advantage of natural daylight to create an enhanced working environment.

- **Electric winch connectors** with additional usability from front and rear sockets.

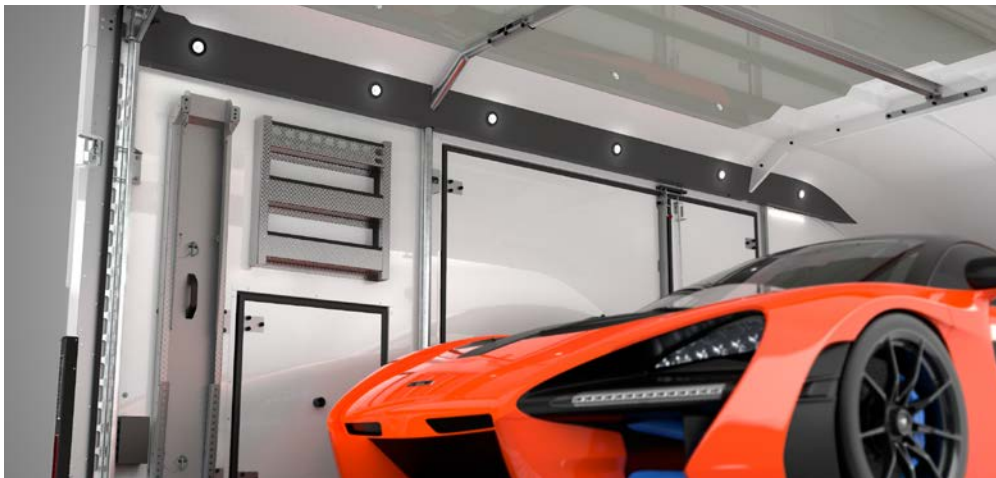

- **x3 LED lighting strips as standard**

- **LED flood light package** fully illuminates the trailer interior. Switched separately. Powered by on-board battery and includes integrated bodywork housings.

● Standard ○ Optional at extra cost



 **LED** BRIGHTLIGHT TECHNOLOGY

- **Full LED lighting**
LED lights are both super bright and reliable. All lamps are LED technology as standard.

LED lamps: Note
LED lamps are not compatible with all towing vehicles. This may cause unintended consequences. Please check compatibility.

- Fully adjustable, quick release, full width wheel chock
Suitable for cars with low splitters.

- Commercial type wheel chocks also available. (see p24)

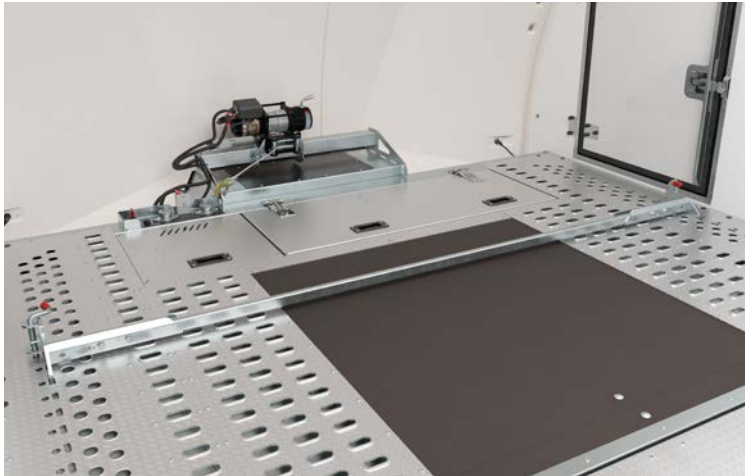

- Multiple anchor points and high strength decking provides strap attachment locations and a high level of grip.

- Optional deck slick pads are available to protect race tyres.

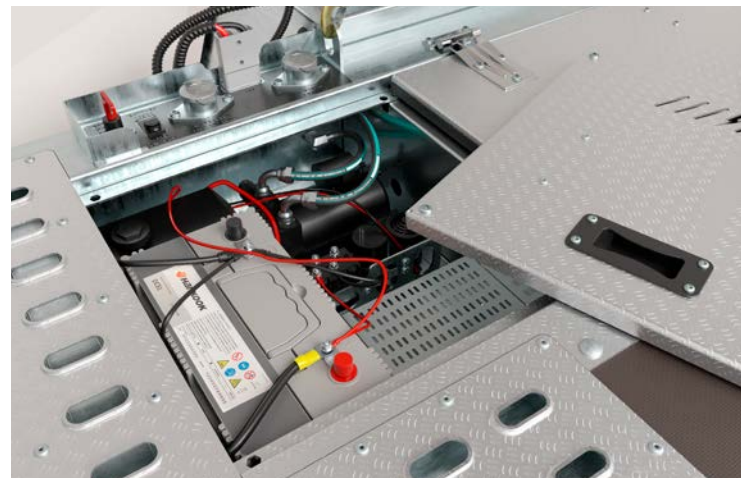
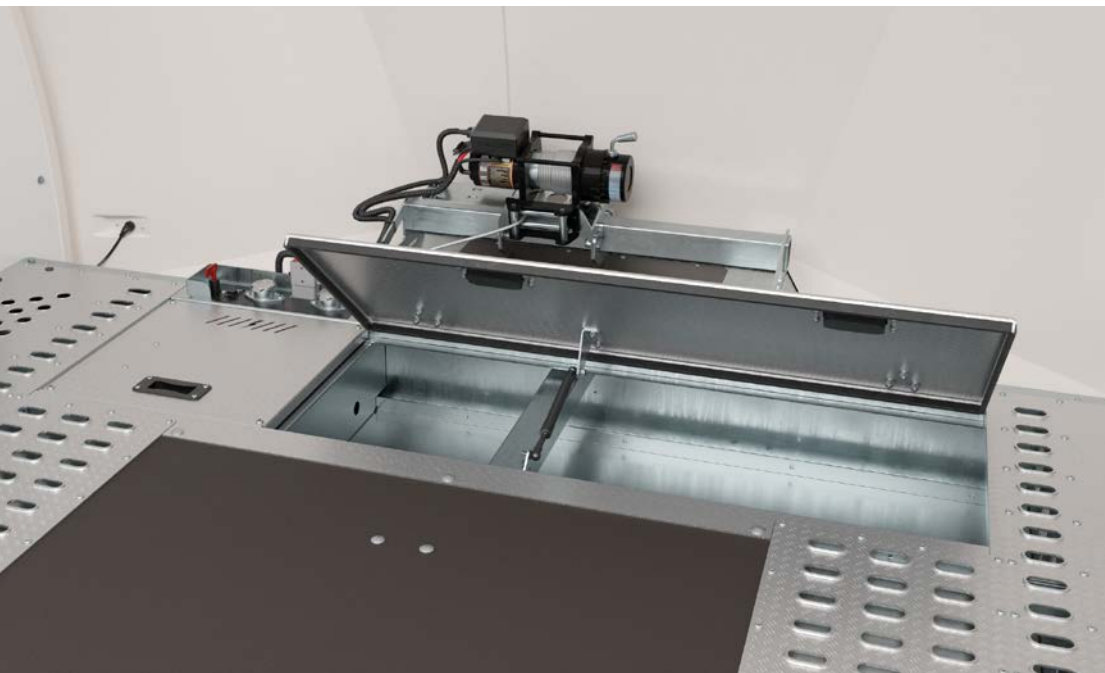

- Tie-down wheel 'sleeve' straps
Approved by car manufacturers and race teams alike, these straps hold the vehicle safely and securely without straining the suspension geometry.

- Power and systems enclosure allows easy access to battery, hydraulic pump and optional control units.

- Front floor storage tray with aluminium gas strut assisted lid provides an ideal location for heavy/bulky items.

● **Triple axle** and light weight **low chassis** ensures excellent stability.



○ **Wheel options**
Alloy wheels available in Silver or diamond cut Anthracite.



● **Floor storage trays** with aluminium gas strut assisted lids provide an ideal location for heavy/bulky items.

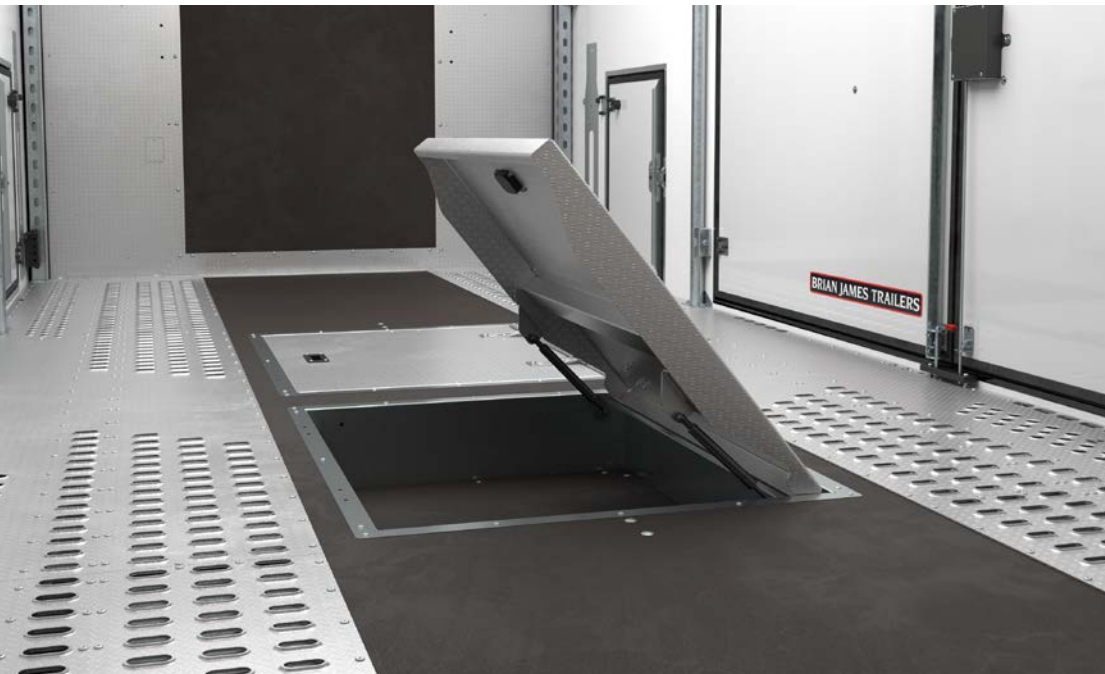

● **Body Colour**
Race Transporter 6 range is available in white or black bodywork.



● Standard ○ Optional at extra cost

RACE TRANSPORTER 6

RACE TRANSPORTER

OPTIONS

We've got everything covered

Race Transporters represent the result of 25 years of innovation and development of enclosed transportation trailers. Our focus throughout has been to enable customers to choose the trailer specific to their needs, built up from a practical standard specification.

To that end a comprehensive range of options has been carefully created and is offered to provide tailored solutions for your individual requirements.

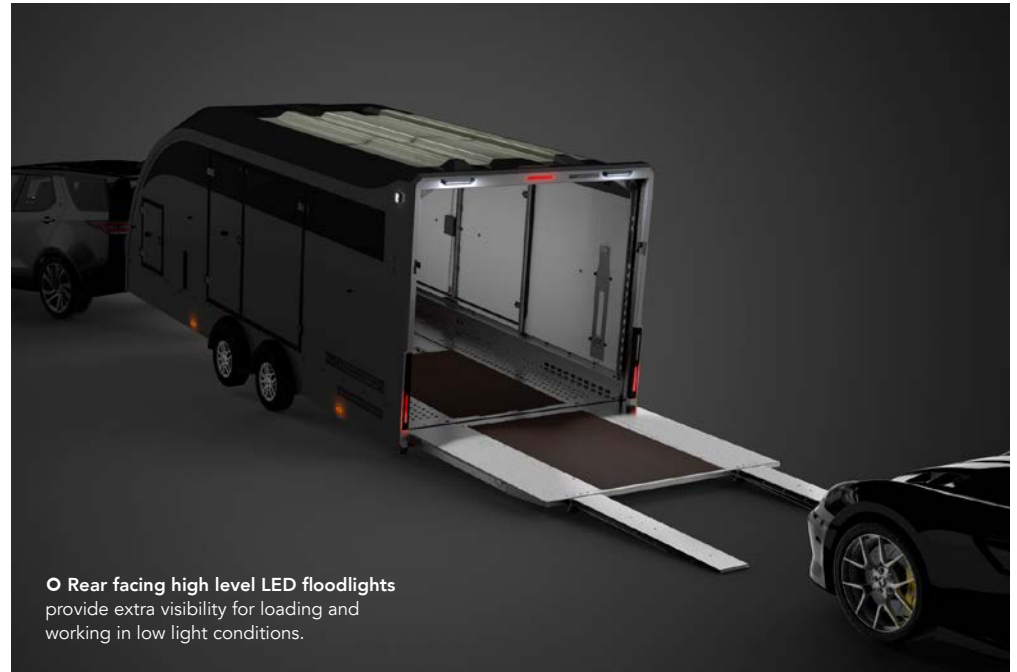

○ **Rear facing high level LED floodlights** provide extra visibility for loading and working in low light conditions.



○ **LED flood light package** fully illuminates the trailer interior. Switched separately. Powered by on-board battery and includes integrated bodywork housings.

○ **Additional reverse lights** Super bright side mounted LED reverse lights provide valuable extra visibility for close movement at night.

○ **Awning**

For added protection from the elements, this proven design is available in single or double sided versions.



○ **Solar panel**

Roof mounted solar panel trickle charges the tilt bed battery.



○ **Rear-view camera**

For backing into tight spaces, a rear-view camera provides assistance and reassurance.



○ **Wheel options**

Alloy wheels available in Silver or diamond cut Anthracite. Alloy wheels features BJT centre caps and safety locking wheel bolts.



○ **360° vision**

Four cameras enable 360° vision for all round visibility and safe manoeuvring. With a wirelessly connected monitor in the tow vehicle, the screen can switch views based on the indicator position.



○ **Aluminium side storage racks**

Pair (LH and RH) of 3 shelf storage racks for smaller items. 600mm wide x 76mm deep.



○ **Hand wash station, 2.5 litre, self contained** with the ability to hold and maintain warm water. Basin folds away when not in use.

○ **Paper towel dispenser**



○ **Mains power unit and USB charge points**

With three mains sockets and two USB charging points, the distribution box allows for use of multiple devices when the trailer is connected to the mains.



○ **Deck slick pads**

Cars with soft compound or 'slick' tyres, can benefit from deck slick pads placed under each tyre. This raises the tyre contact area level with the punched deck.



○ **Commercial type wheel chocks**

For use with vehicles with higher ground clearance. Fully adjustable, quick release wheel chock system engages directly into the trailer chassis.



○ **Tie-down wheel 'sleeve' straps**

Approved by car manufacturers and race teams alike, these straps hold the vehicle safely and securely without straining the suspension geometry.

Standard on Race Transporter 5 and 6.

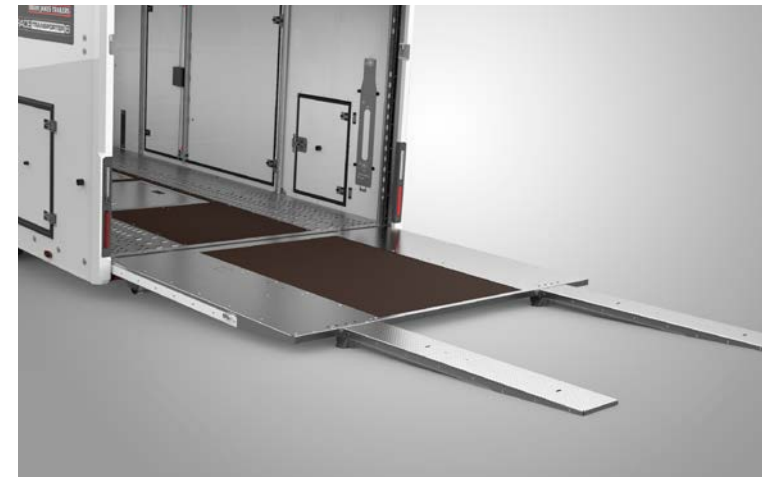

○ **Assistor ramps offer ultra-low loading angles.**

Stored just inside the trailer rear door for travel.

○ **Store station** with storage shelves and facility to carry 20 litre Jerry cans.

Race Transporter 4 & 5 only.

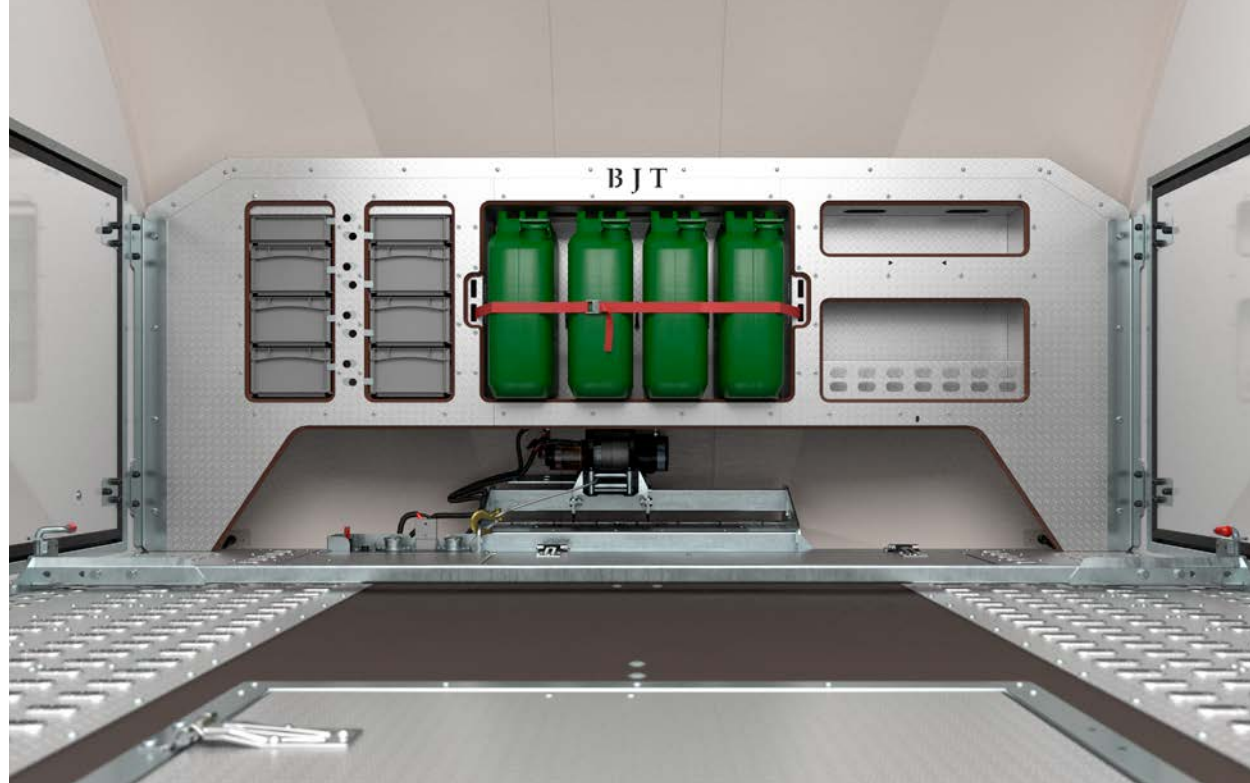

○ **Premium store station** increases storage capacity with 4 x 20ltr Jerry can capacity and incorporates 8 removable storage bins, ideal for organising smaller components.

The upgrade is completed by an aluminium triple-grip fascia.

Race Transporter 5 & 6 only.

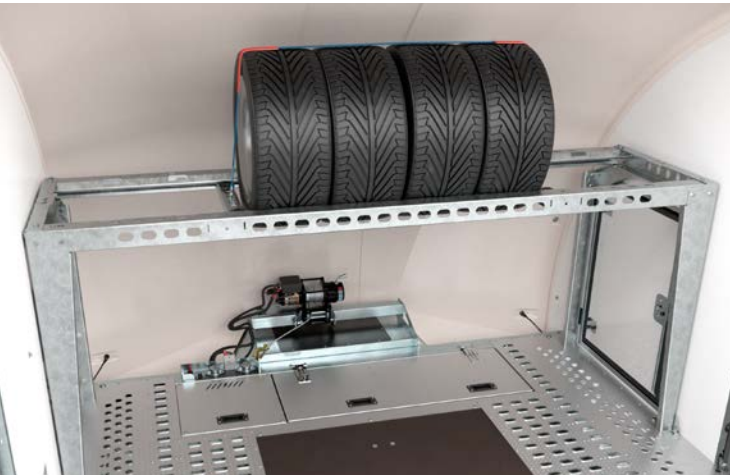

○ **Tyre rack**
Transport of multiple spare wheels and tyres is easily accomplished with a high level tyre rack. Its design places the wheels above average bonnet height, so keeping useful space available on the trailer bed. Safety and security of the transported wheels is provided by a unique strap system.

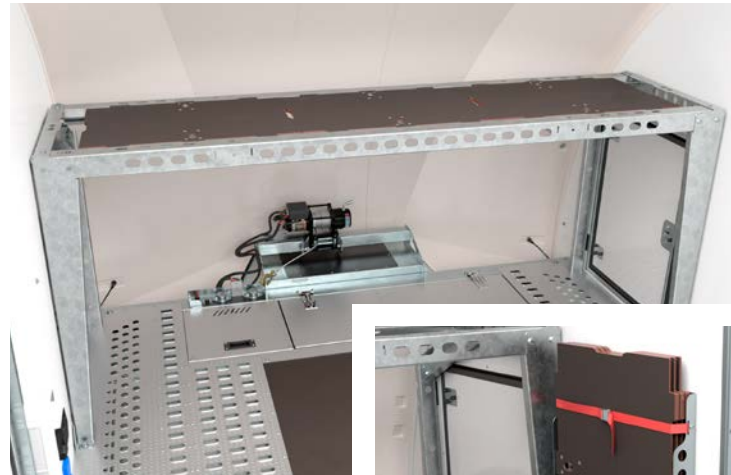

○ **Workbench**
Convert your tyre rack into a usable workbench.

Includes panel station for convenient storage when used as a tyre rack.

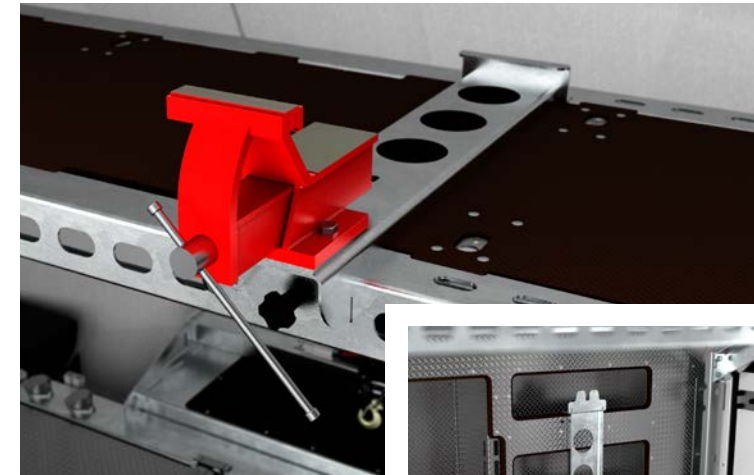

○ **Workbench Vice**
Increase the functionality of your workbench with this fundamental piece of workshop equipment.

Stored out of the way when not in use.

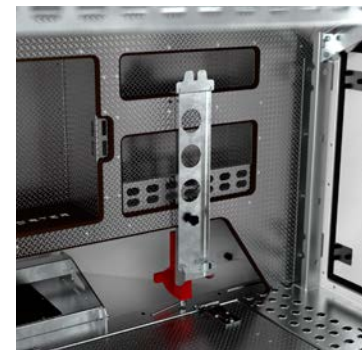

● Standard ○ Optional at extra cost

RACE TRANSPORTER

RACE TRANSPORTER 4 & 5 STANDARD EQUIPMENT

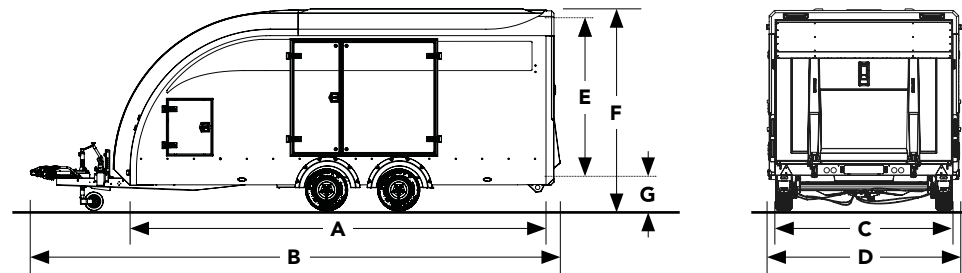

MODEL	RACE TRANSPORTER 4				RACE TRANSPORTER 5			
PRODUCT CODE	384-0041	384-1041	384-0060	384-1060	385-1090	385-2090	385-1100	385-2100
CAPACITY								
Gross kg	3,500	3,500	3,500	3,500	3,500	3,500	3,500	3,500
Load kg	2,320	2,320	2,260	2,260	2,300	2,300	2,260	2,260
Unladen trailer weight kg	1,170	1,170	1,240	1,240	1,200	1,200	1,240	1,240
DIMENSIONS								
Chassis length m A	5.00	5.00	5.50	5.50	5.50	5.00	5.50	5.50
Minimum usable bed length m	4.85	4.85	5.35	5.35	5.35	4.85	5.35	5.35
Overall length m B	6.65	6.65	7.12	7.12	6.65	6.65	7.12	7.12
Internal width m C	2.12	2.12	2.12	2.12	2.12	2.12	2.12	2.12
Overall width m D	2.51	2.51	2.51	2.51	2.50	2.50	2.50	2.50
Internal height m E	1.88	1.88	1.88	1.88	1.88	1.88	1.88	1.88
Overall height (unloaded) m F	2.53	2.53	2.53	2.53	2.53	2.53	2.53	2.53
Bed height (unloaded) m G	0.48	0.48	0.48	0.48	0.48	0.48	0.48	0.48
OPERATION								
Hydraulic tiltbed	●	●	●	●	●	●	●	●
Electric winch plus battery onboard	●	●	●	●	●	●	●	●
Coupling head with integral high security lock	●	●	●	●	●	●	●	●
EXTERIOR/DOORS								
Body colour	White	Black	White	Black	White	Black	White	Black
Full body length black vinyl body stripe package	—	—	—	—	●	—	●	—
Side doors	Gullwing (2 sides)	Gullwing (2 sides)	Gullwing (2 sides)	Gullwing (2 sides)	Twin (2 sides)	Twin (2 sides)	Twin (2 sides)	Twin (2 sides)
Front access hatches	●	●	●	●	●	●	●	●
Rear door – aluminium/steel construction with body moulding	●	●	●	●	●	●	●	●
Daylight roof	●	●	●	●	●	●	●	●
RUNNING GEAR								
Wheel size	12" (155/70)	12" (155/70)	12" (155/70)	12" (155/70)	12" (155/70)	12" (155/70)	12" (155/70)	12" (155/70)
Axles	2	2	2	2	2	2	2	2
Spare wheel	●	●	●	●	●	●	●	●
Heavy duty jockey wheel	●	●	●	●	●	●	●	●
WARRANTY								
5 year extended chassis warranty	●	●	●	●	●	●	●	●

RACE TRANSPORTER 6

STANDARD EQUIPMENT

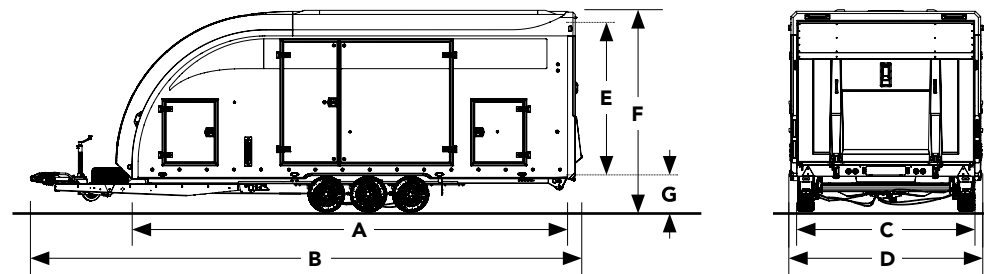

MODEL	RACE TRANSPORTER 6									
PRODUCT CODE	396-2010	396-3010	396-2030	396-3030	396-2020	396-3020	396-2040	396-3040	396-2060	396-3060
CAPACITY										
Gross kg	3,500	3,500	3,500	3,500	3,500	3,500	3,500	3,500	3,500	3,500
Load kg	2,020	2,020	2,000	2,000	1,960	1,960	1,930	1,930	1,820	1,820
Unladen trailer weight kg	1,480	1,480	1,500	1,500	1,540	1,540	1,570	1,570	1,680	1,680
DIMENSIONS										
Chassis length m A	5.50	5.50	5.50	5.50	6.00	6.00	6.00	6.00	6.50	6.50
Minimum usable bed length m	5.38	5.38	5.38	5.38	5.88	5.88	5.88	5.88	6.38	6.38
Overall length m B	7.20	7.20	7.20	7.20	7.70	7.70	7.70	7.70	8.20	8.20
Internal width m C	2.12	2.12	2.29	2.29	2.12	2.12	2.29	2.29	2.29	2.29
Overall width m D	2.39	2.39	2.56	2.56	2.39	2.39	2.56	2.56	2.56	2.56
Internal height m E	1.88	1.88	1.88	1.88	1.88	1.88	1.88	1.88	1.88	1.88
Overall height (unloaded) m F	2.64	2.64	2.64	2.64	2.64	2.64	2.64	2.64	2.67	2.67
Bed height (unloaded) m G	0.58	0.58	0.58	0.58	0.58	0.58	0.58	0.58	0.67	0.67
OPERATION										
Loading operation (electric hydraulics – includes built-in battery level indicator/gauge)	●	●	●	●	●	●	●	●	●	●
Electric winch plus battery on-board	●	●	●	●	●	●	●	●	●	●
Cast steel coupling head with integral high security lock	●	●	●	●	●	●	●	●	●	●
Adjustable wheel chock – quick release, 55mm high, suitable for cars with low splitters	●	●	●	●	●	●	●	●	●	●
Pre-galvanised storage tray – central x2 and front x2	●	●	●	●	●	●	●	●	●	●
EXTERIOR/DOORS										
Body colour	White	Black	White	Black	White	Black	White	Black	White	Black
Full body length black vinyl body stripe package (not available on black body option)	●	●	●	●	●	●	●	●	●	●
Exterior LED lighting all round	●	●	●	●	●	●	●	●	●	●
Side doors	Twin (2 sides)	Twin (2 sides)	Twin (2 sides)	Twin (2 sides)	Twin (2 sides)	Twin (2 sides)	Twin (2 sides)	Twin (2 sides)	Twin (2 sides)	Twin (2 sides)
Front and rear access hatches	●	●	●	●	●	●	●	●	●	●
Rear door – aluminium and steel construction with body moulding	●	●	●	●	●	●	●	●	●	●
Daylight roof	●	●	●	●	●	●	●	●	●	●
RUNNING GEAR										
Wheel size	10" (195/55)	10" (195/55)	10" (195/55)	10" (195/55)	10" (195/55)	10" (195/55)	10" (195/55)	10" (195/55)	13" (195/55)	13" (195/55)
Axles	3	3	3	3	3	3	3	3	3	3
Spare wheel	●	●	●	●	●	●	●	●	●	●
Heavy duty jockey wheel	●	●	●	●	●	●	●	●	●	●
WARRANTY										
5 year extended chassis warranty	●	●	●	●	●	●	●	●	●	●

● Standard — Not available

*Weights stated are approximate and are based on a trailer with no optional extras fitted

RACE TRANSPORTER 4, 5 & 6

OPTION PACKS & OPTIONS (Please note that all options within each pack are also available separately)

MODEL	RT 4	RT 5	RT 6
LIGHTING PACK			
PACK CONTENTS			
Rear LED trailer lighting	○	●	●
LED reverse lights – side mounted (factory fitted – dealer fit kit will incur fitting charge)	○	○	○
Rear exterior LED loading lamps – automatically engaged when side lights of vehicle are on and rear door is open	○	○	○
Interior LED light strips x 3	○	●	●
Interior LED flood light package	○	○	○
STORAGE PACK			
PACK CONTENTS			
Pre-galvanised storage tray x2 – central, below bed	○	●	●
Hinged aluminium lid x2 + gas strut assistance – for central aluminium storage trays	○	○	○
Hinged aluminium lid x2 + gas strut assistance – for front aluminium storage trays	—	—	○
Aluminium side storage racks (pair, one each side)	○	○	○
MOTORSPORT PACK			
PACK CONTENTS			
Lightweight assistor ramps – ultra low loading facility (pair)	○	○	○
Tyre rack – high level rack with securing system	○	○	○
Work bench (must be ordered with tyre rack)	○	○	○
Tie-down straps – red, set of 4 x wheel circumference straps, 3000 DaN/Kg; strap over circumference of each of the vehicle's tyres	○	●	●
RT6 TECHNOLOGY PACK			
PACK CONTENTS			
Remote control bed tilt function controlled by smartphone app	—	—	○
Bluetooth battery indicator	—	—	○
Battery charger from mains connection – CTEK technology with quick connect plug	—	—	○
Winch radio control system	—	○	○

MORE OPTIONAL EQUIPMENT

RACE TRANSPORTER 4 & 5

MODEL	RT 4	RT 5
WHEELS		
Alloy wheels – (colour Silver) + safety locking bolts and alloy spare	○	○
Alloy wheels – (colour Anthracite, diamond cut) + safety locking bolts and alloy spare	○	○
OPERATION		
Adjustable wheel chock – quick release, 55mm high, suitable for cars with low splitters	○	●
Adjustable wheel chock – quick release (red), commercial car transporter type	○	○
Deck slick pads x4, red - protect soft compound racing tyres from the punched deck	○	○
INTERIOR		
Front store station	○	—
Front store station – premium	—	○
Bench vice (only compatible if optional tyre rack is fitted, see details on previous page within Motorsport Pack section)	○	○
Hand wash station with warm water store	○	○
Paper towel dispenser	○	○
SAFETY/SECURITY		
Datatag – security identification system	○	○
Wheel safety kit – torque wrench with 19mm socket and digital tyre pressure gauge	○	○
Tyre pressure monitoring system by TyrePal (in car monitor with external sensors)	○	○

RACE TRANSPORTER 6

Models	Standard models	386–2060 model
WHEELS		
Alloy wheels – (colour Silver) + safety locking bolts and alloy spare	○	○
Alloy wheels – (colour Anthracite, diamond cut) + safety locking bolts and alloy spare	○	—
2nd spare wheel – steel	○	—
2nd spare wheel – alloy (colour Silver)	○	—
2nd spare wheel – alloy (colour Anthracite, diamond cut)	○	—
OPERATION		
Adjustable wheel chock – quick release (red), commercial car transporter type	○	○
EXTERIOR		
Exterior body colour option – black (includes side panels, roof, nose and rear door)	○	○
INTERIOR		
Front store station – premium	○	○
Bench vice (only compatible if optional tyre rack is fitted, see details on previous page within Motorsport Pack section)	○	○
Hand wash station with warm water store	○	○
Paper towel dispenser	○	○
SAFETY/SECURITY		
Datatag – security identification system	○	○
Wheel safety kit – torque wrench with 19mm socket and digital tyre pressure gauge	○	○
Tyre pressure monitoring system by TyrePal (in car monitor with external sensors)	○	○

● Standard ○ Optional at extra cost — Not available

RACE TRANSPORTER

QUALITY

Brian James Trailers are manufacturers of class leading trailers since 1979. When you buy a Brian James Trailer you can be absolutely certain that it is designed and constructed to the highest possible standards. Our engineers combine top-quality craftsmanship with the best materials and first-class presentation. Light but strong, our trailers are crafted to enhance safety, efficiency and durability.

5 Year Extended Chassis Warranty

All of our trailers come with a standard 1 year non-transferable manufacturer's warranty covering the integrity of the chassis, which can be extended to 5 years at no additional charge upon registration.

This 5 year extended warranty applies to the chassis only. All other components are subject to a standard 1 year warranty, subject to fair wear and tear.

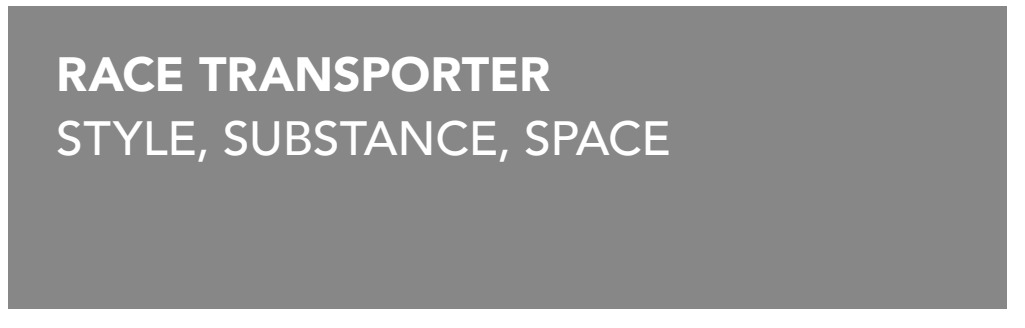

Standards



* 1 year warranty as standard. Additional 4 year warranty period requires product registration.



BRIAN JAMES TRAILERS

» Connected to you

NOTES

All images used are for illustrative purposes only and may show non-standard equipment and finishes. All products are subject to change without prior notice due to our continuous development programme.

© BRIAN JAMES TRAILERS LIMITED

Edition RTRANS2021_Q2_1

Brian James Trailers Limited.
Sopwith Way, Drayton Fields Industrial Estate
Daventry, Northampton, NN11 8PB

T + 44 (0)1327 308 833

Brian James Trailers are available by contacting our sales team as well as through an extensive network of official dealers throughout the country.

For more information please call or visit our website.

www.brianjamestrailers.co.uk



THE QUEEN'S AWARDS
FOR ENTERPRISE:
INTERNATIONAL TRADE
2018

Dealer information

